

**Panasonic**  
ideas for life

10-Series  
**Professional Plasma Displays**

Superior Image Quality / Long Service Life / Ecological Design

**Panasonic**  
ideas for life

Simulated pictures on screen.  
Specifications are subject to change without notice.

Panasonic

# The truly professional plasma displays

Panasonic plasma displays are designed with the superior panel performance and innovative features needed in professional applications. With models ranging from 42 inches to an industry-leading\* 103 inches, our lineup is broad enough to meet every professional need. And Panasonic's signature multi-function slot system makes it possible to use our displays in almost any AV, PC or interactive environment, giving you outstanding versatility too.

\* World's largest plasma display as of September 15, 2006, according to a Panasonic study

# 10,000:1

## High Contrast Ratio

Panasonic takes specifications to even higher levels with its incredible 10,000:1 contrast ratio,\* allowing our plasma displays to provide remarkable images in nearly any viewing environment. They reproduce beautiful images with tight, rich blacks – a hallmark of high-quality plasma displays – as well as smooth, naturally toned gradation and outstanding depth.

\* All models except the 103-inch model, which has 5,000:1 contrast ratio.

## Smooth, Crisp Motion Images

Panasonic plasma displays reproduce motion images with the high resolution needed to deliver the full beauty of high-definition broadcasts. Even fast-moving images are crisp, sharp, and smooth, perfect for viewing fast-paced content such as action movies and sports.

Panasonic

## Faithful Colours

Panasonic plasma displays provide superior colour reproduction over every part of the image.

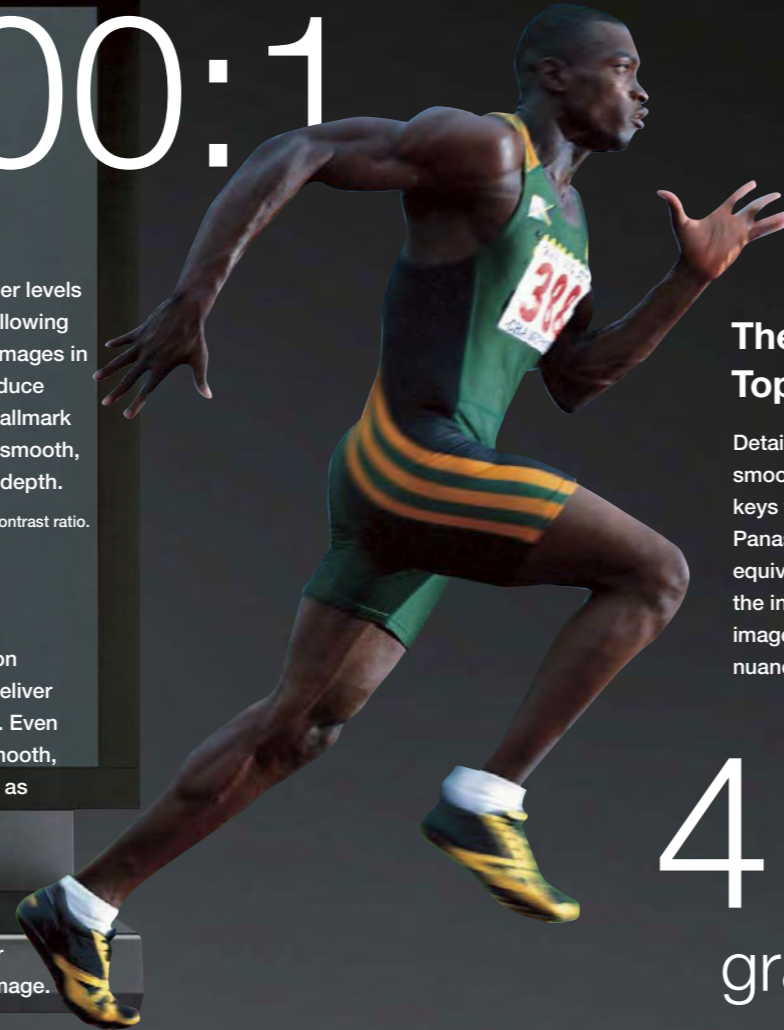

## The Industry's Top Level of Gradation

Detailed gradation is essential for reproducing smooth, natural colours. This is one of the keys to the unsurpassed image quality of Panasonic plasma displays. Achieving the equivalent of 4,096 gradation steps – best in the industry – Panasonic plasmas render images with natural coloration, subtle nuancing and exquisite detail.

# 4,096

gradation steps

# 187

cars

## Lead-Free

Panasonic was first in the world to make totally lead-free plasma display panels. Eliminating lead reduces impact on the environment when the products are recycled or disposed of at the end of their service life. By making our plasma displays lead-free, we reduce lead use by 280.5 tons each year – about the same total weight as 187 automobiles.\*

\* Calculated assuming a weight of 1.5 tons per automobile.



# 100,000

hours

## Long Service Life

With Panasonic plasmas, the beauty lasts and lasts—thanks to a service life of about 100,000 hours.\* That's an amazing 42 years of normal viewing (6.5 hours per day) or 11.5 years of continuous use (24 hours per day). Unlike LCDs, plasma displays do not use a backlight where the brightness fades over time. This means they can provide bright, beautiful pictures over many years of use. Further, the plasma display screen is covered by a glass panel for enhanced protection against impact and scratches.

\* The time until panel brightness is reduced to half its initial level, when displaying moving images in standard mode. Excludes afterimages and malfunctions. PH and PS series offer a service life of about 60,000 hours.



Panasonic's wide-ranging lineup: From a 103-inch Full HD model to a 42-inch SD model

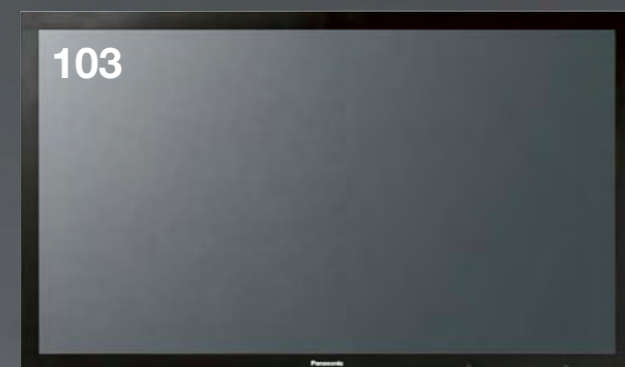

TH-103PF10TK



Full HD

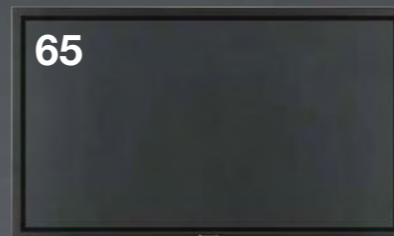

TH-65PF10TK

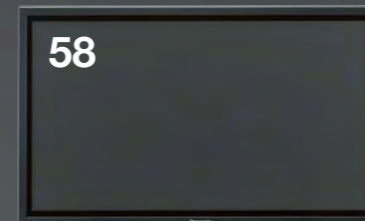

TH-58PH10TK

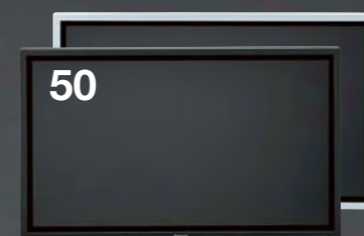

TH-50PH10TK/TS

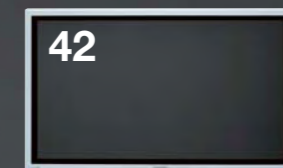

TH-42PH10TS

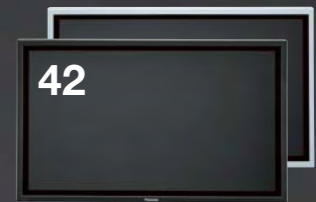

TH-42PS10TK/TS

SD



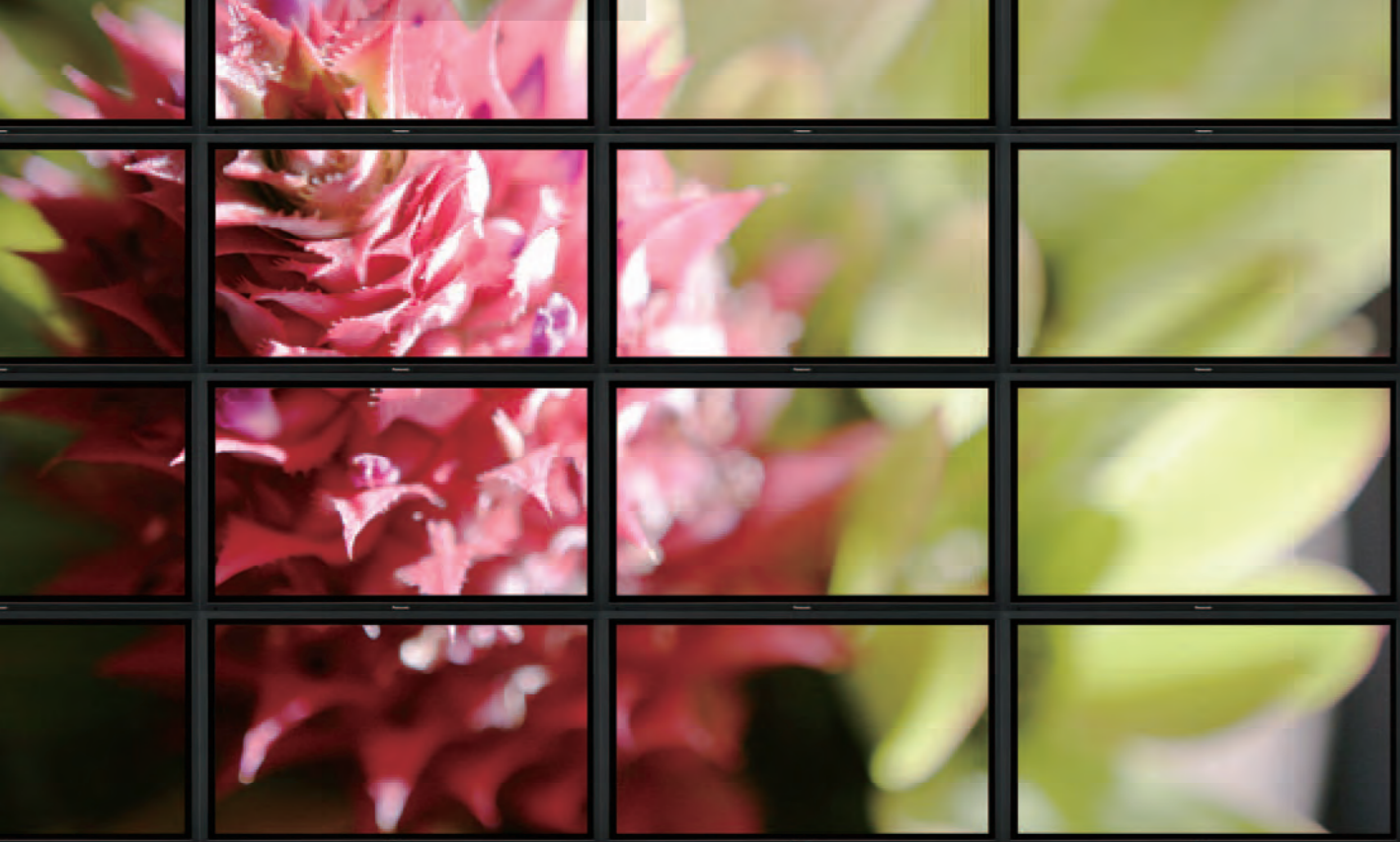

### Advanced Multi-Screen Capability

The multi-screen video wall capability has been expanded to a maximum of 5 x 5 screens – the largest in the industry. This gives you a powerful, eye-catching way to present visual information at airports, shopping malls, and other large facilities. You can create a system that packs an incredible visual punch.

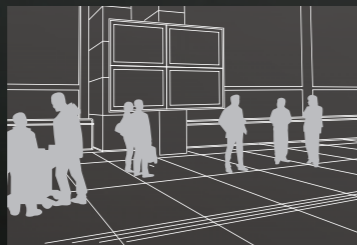

Airport

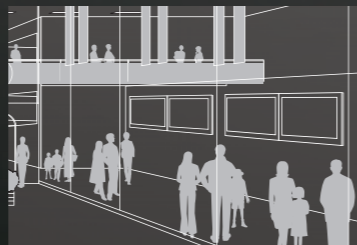

Shopping mall

## In Commercial Establishments Everywhere, You'll Find Panasonic Plasma Displays Delivering World-Class Performance

### Portrait Zoom

This function makes it easy to display portrait-oriented (vertical) images that were originally in a landscape (horizontal) orientation. It divides the original image into three vertical sections and displays one of those vertical sections in portrait orientation. This is useful in a multi-screen system with three display units. Set the three units side by side in portrait orientation, and you can use Portrait Zoom to display an enlarged three-part image that delivers outstanding visual impact. Use it to create dynamic movie previews or, in a system with three of Panasonic's huge 103-inch plasma displays, to promote a new car by showing life-size images of it. Portrait Zoom is compatible with all types of input signals, including HDMI, RGB, DVI, HD-SDI, component and composite.

Transportation

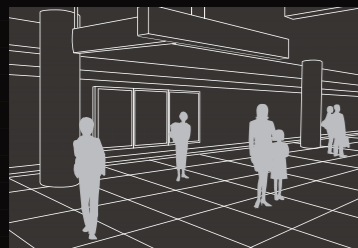

Amusement facility



*With three of Panasonic's industry-leading 103-inch models set side by side in portrait orientation, you can deliver information with a visual power and impact that conventional systems can't even approach.*

Boutique



*A section of an image in landscape orientation can be "cut out" and displayed in portrait orientation on a huge 103-inch plasma display. In a boutique, for example, you could use this feature to display life-size images of fashion models on a catwalk.*



### Wireless Presentation Board

This board lets you display images with wireless ease via 802.11 b/g WiFi – no RGB cable connection is necessary. Each plasma display can be wirelessly connected to up to 16 PCs. Also, data from one PC can be transmitted to up to eight plasmas for simultaneous display. A wireless system takes a lot of the trouble out of getting ready for an important presentation. You can forget about preparing cables beforehand, and setup is smooth and quick. The wireless presentation board is especially convenient for use in conference rooms and schools.



Conference room





# Ultimate Full HD Plasma Displays with 10,000:1 Contrast, 4,096 Gradation Steps and 100,000-Hour Service Life

**FULL HD 1080p**



**TH-65PF10TK**  
65-inch (165 cm) diagonal  
Full High Definition Plasma Display



**TH-103PF10TK**  
103-inch (260 cm) diagonal  
Full High Definition Plasma Display

## Explore a Wider World of Video Applications

### PRESENTATIONS

Panasonic Full HD models provide a big-screen display of data such as CAD images with outstanding clarity, detail and colour accuracy. Able to display highly detailed documents and images with exceptional clarity and sharpness, Panasonic plasmas are suitable for use in conferences and presentations with large audiences.



### TV-VIDEO PRODUCTION

Panasonic Full HD models reproduce colours across the entire HDTV-standard range, so colours from HD sources are faithful and natural-looking. Supporting 10-bit input signals, the HD-SDI terminal board achieves precise colour reproduction and rich gradation.



### MONITORING

Our 103-inch model is perfect for control rooms where crystal-clear display of detailed information is essential. In image quality, Panasonic Full HD plasma models easily outperform projection displays. They can also be installed in places where bulky conventional direct-viewing displays could not.



### DIGITAL SIGNAGE

With an industry-leading 4,096 gradation steps, Panasonic Full HD plasma models realistically convey the texture and surface quality of objects. With the 103-inch model in portrait orientation, images of people can be shown in actual life-size to draw attention.



### Full HD Plasma Panel — Twice as Much Image Information

Our Full HD plasma models feature about 2 million pixels (1920 horizontal x 1080 vertical) — about twice as many as our conventional HD models. Images are uniformly clear, sharp and super-detailed across the entire screen surface.

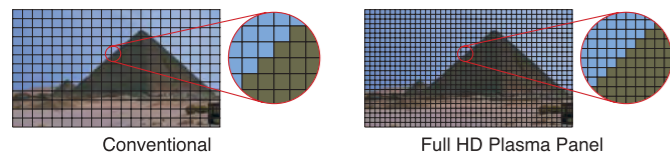

### Superior Moving Image Resolution

Plasma display panels use a self-illuminating system to boost resolution in images with fast motion. Panasonic brings out all the beauty inherent in Full HD, reproducing crisp, sharp images that move smoothly.

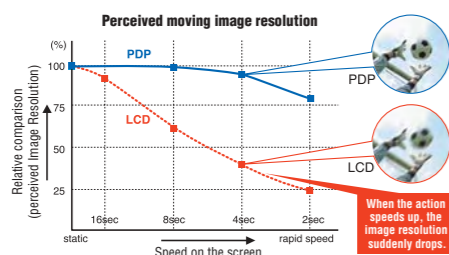

### 4,096 Equivalent Steps of Gradation

Thanks to Panasonic's advanced maximum 16-bit digital image processing, our plasma models reproduce crisp, clear motion picture images with the equivalent of 4,096 gradation steps. This industry-leading gradation level enhances image depth, and conveys fine detail.

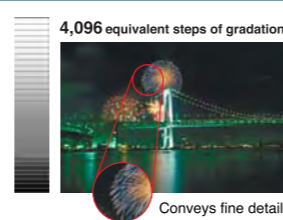

### Deep, Crisp Blacks with 10000:1\*1 Contrast

Panasonic's original New Real Black Creation technology helps achieve high contrast of 10,000:1\*1 in dark image areas to reproduce exceptionally deep, rich blacks.

\*1: 5,000:1 for 103-inch model.

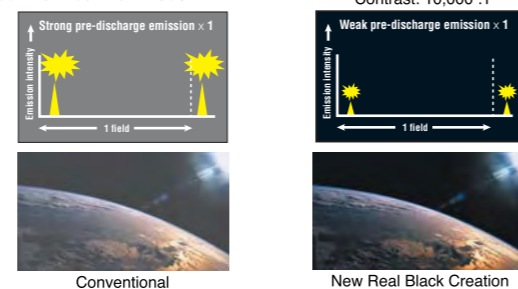

### Reproducing the Entire HDTV Colour Range

HD sources are based on the HDTV standard rather than the conventional NTSC standard. In our new Full HD models, the panel phosphor characteristics closely match the HDTV-standard colour gamut. This lets our plasmas reproduce the entire colour range specified in the HDTV standard (ITU-R. BT709), so images are faithful to the original HD source.

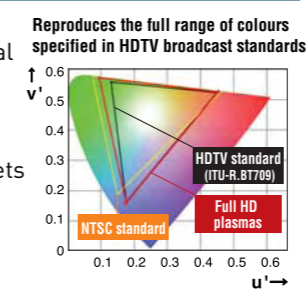

### Digital Colour Reality for Accurate Colour Reproduction

In Super Cinema mode, Digital Colour Reality boosts precision in the digital control of colour and brightness video data. By continuously adjusting the white balance and performing gamma correction as scenes change, this technology accurately creates the kind of faithful ambience that was difficult for previous systems to deliver.



### Less Digital-Video Noise

Noise reduction circuitry suppresses the block noise and mosquito noise that are specific to HDTV broadcasts and other digital video signals (MPEG video). This allows images to be faithfully reproduced in all their original beauty.

#### • Block Noise Reduction

The noise reduction circuit detects and eliminates block noise that is generated when compressing motion images with an inadequate bit rate.

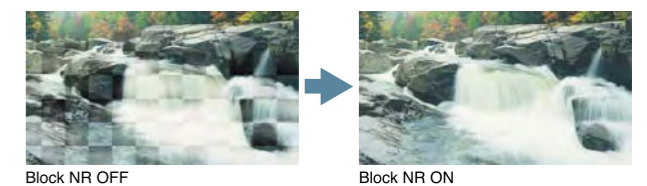

#### • Mosquito Noise Reduction

The noise reduction circuit reduces mosquito noise that is generated when compressing motion images, particularly at the edges of characters and in parts where rapid colour changes occur.

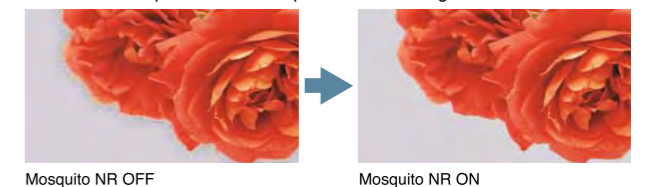



# Industry-Leading HD/SD Plasma Displays — Advanced Technologies Deliver Superb Picture Quality

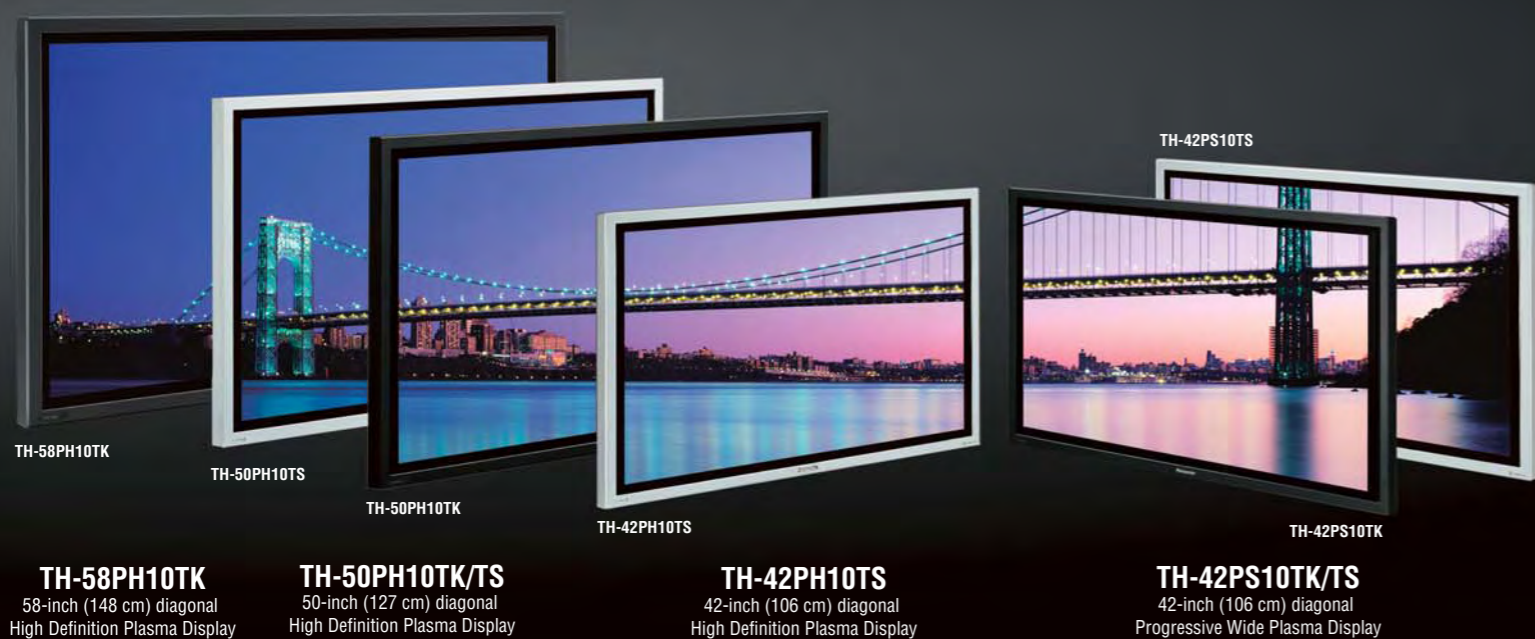

**TH-58PH10TK**  
58-inch (148 cm) diagonal High Definition Plasma Display

**TH-50PH10TS**  
50-inch (127 cm) diagonal High Definition Plasma Display

**TH-50PH10TK**  
50-inch (127 cm) diagonal High Definition Plasma Display

**TH-42PH10TS**  
42-inch (106 cm) diagonal High Definition Plasma Display

**TH-42PS10TK**  
42-inch (106 cm) diagonal Progressive Wide Plasma Display

## Explore a Wider World of Video Applications

### WIRELESS PRESENTATION

At business meetings, presentations and other situations calling for powerful visual impact, you can count on the 58-inch HD plasma display. An optional wireless presentation board makes it easy to get a presentation or meeting underway quickly, without the time and trouble of connecting a number of cables.



### PUBLIC INFORMATION

Ideal as public information systems, Panasonic 50-inch HD plasmas offer ultra-flexible installation: mount them vertically and add a touch panel for one-on-one interaction.



### DYNAMIC SIGNAGE

The Panasonic 42-inch pro plasma model fits well in stores. It can display images from two video sources at the same time, making it ideal for information displays in stores, show windows and other uses.



### ENTERTAINMENT

The Panasonic pro plasma model is perfect when space is at a premium. You can select the model with the most suitable screen size for a specific installation space. Thanks to its high motion-image resolution, the plasma panel is ideal for displaying motion images. Function slots let you customize the unit for specific applications.

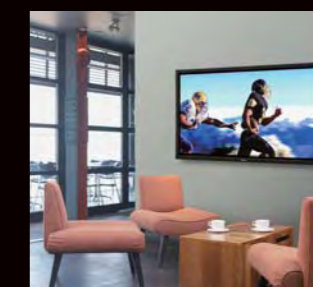

### Advanced 16-bit Image Processing — Real Gamma Control

Panasonic plasma displays use maximum 16-bit processing, to process video signals all the way up to the gamma correction stage. Real Gamma Control reproduces the actual image that appears on the screen at 3,072\*<sup>1</sup> equivalent steps of gradation.

\*1: For PH/PS series. 4,096 equivalent steps for PF series.



Bright image areas with insufficient gradation lack detail.

Clear, detailed rendering of both bright and dark areas.

### Deep, Rich Blacks — New Real Black Creation

Panasonic's original New Real Black Creation technology helps achieve high contrast of 10,000:1 in dark image areas to reproduce exceptionally deep, rich blacks.

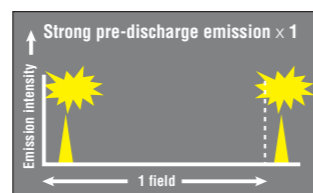

Conventional

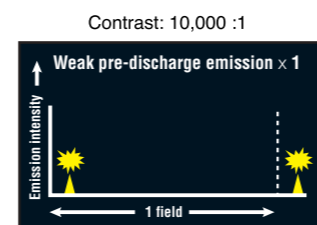

New Real Black Creation

### Even Higher Bright-Area Contrast — New Deep Black Filter

The New Deep Black Filter suppresses light transmittance and slashes the amount of external light reflected. This technology helps improve the contrast when viewed in bright surroundings. Reflection is minimal, so images are clean and distraction-free.

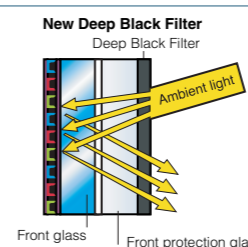

### Sharp, Clear Images — Sub-Pixel Controller

The Sub-Pixel Controller eliminates jagged or blurred diagonal lines and produces smoother edges. This advanced system processes each colour separately for crisper, more natural-looking images.

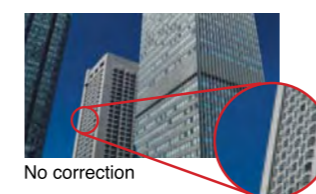

No correction



Correction

### Smooth, Clear Motion Images — Motion Pattern Noise Reduction

The Motion Pattern Noise Reduction circuit detects motion patterns that tend to generate noise, and makes adjustments to maximise image quality. It helps produce clean, sharp images with outstanding gradation, even in scenes with considerable motion. The result is a noticeable improvement in moving picture quality.

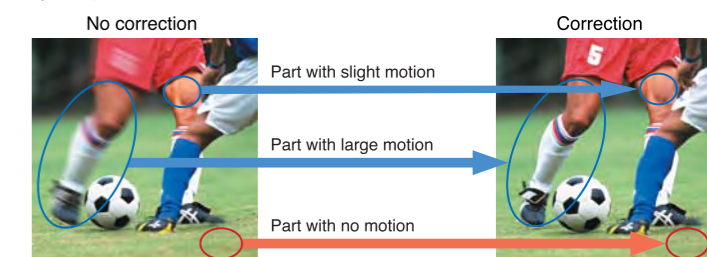

Panasonic plasma finely divides each scene into numerous parts, then detects the motion in each part and applies noise reduction where required.



# Dynamic Images Draw Attention & Strongly Appeal to Viewers



## Life-Size Fashion Models — Digital Signage Displays

The 103-inch plasma display is large enough to display people in life-size scale. The Portrait Zoom function can be used to create extremely eye-catching window displays of fashion show programming with richly shaded images.



## Information Displays Above Counters

The Multi Display function is ideal for putting areas like the space above airport counters to effective use. Sleek, flexibly configurable information display systems give travelers crisp, clear images with excellent contrast.

## Portrait Zoom Function — Useful for Vertical Mounting (PF series only)

By dividing the content from a video source into three vertical segments and displaying one segment on a portrait-position plasma display, a desired section of an image can be displayed dynamically. When three plasma display units are combined in portrait orientation, the entire image can be displayed dynamically on an extra-large screen.

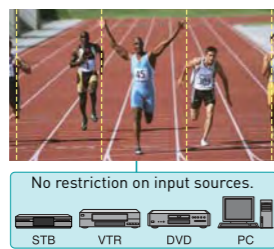

One of the three divided segments can be selected for display.



A full-screen image displayed on three plasma display units.



## Useful Functions in Multi-Screen Systems

### • Power-On Delay Function

This function automatically shifts the power-on time slightly for each display unit in the system, so there's less load on the power supply.

Note: In the PH series, this function is operable only when the Multi Display Setup is turned on. The PS series is not equipped with this function.

### • Seam Hides Video Off Mode

This mode displays a full-screen image, including the edges (the width of the frame) of the display panel. This is especially suitable for displaying text information, since no words are hidden by the frame.



### • Multi AI Control Function (PF series only)

By applying AI control to the brightness signal of the entire input using the same video processing as for a single-screen image, this new function achieves a uniform brightness level over the entire image.

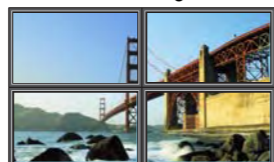

Because video information is processed individually for each display unit, images may appear darker than on other display units.

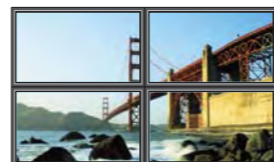

Since video information is processed for the entire input signal, there is no brightness difference from other display units.

### • Display ID Control Function

The remote control that comes with the display is equipped with a "Display ID Control" function that allows you to control up to 100 displays with the one remote.

## Multi Display Function

This built-in image-enlarging function makes it easier to set up multi-screen systems with as many as 25 displays (5x5 configuration).

A new function lets you enlarge the image up to 5x vertically and horizontally independently, making it easy to set up a multi-screen system with up to five displays arranged either vertically or horizontally. For example, expand the image horizontally to 5x and leave it unchanged vertically, and you can create a system with five units side-by-side.

Note: Images of SXGA resolution or higher from a PC or RGB source may not enlarge correctly. PH series enlarges the image up to 4x vertically and horizontally. PS series is not equipped with this N x M image-enlarging function.



## Digital Banners Utilize Vertical Space

Multi-screen systems can be easily configured to make effective use of the vertical space in locations such as entranceways and lobbies. These digital banners catch widespread attention with their unique combination of sophistication and visual appeal.

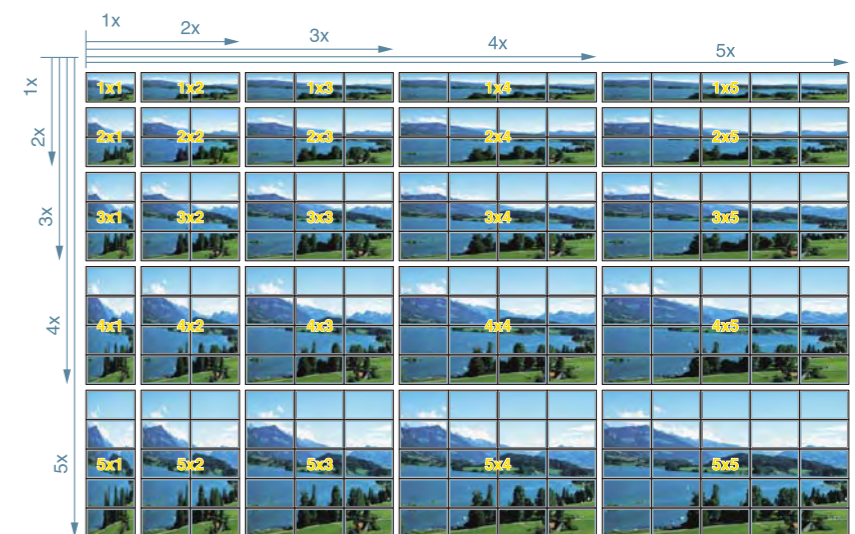

1x5 enlarged image



# Advanced Functions Help Create Effective Digital Signage



## Storefront Advertising with Effective Displays of Moving Images and Text Messages

Panasonic pro plasma models add impact to your message and draw substantial attention to your product, service, event or whatever you are marketing or communicating.



## Distribution and Display of Various Types of Information via Networks

An optional plug-in PC board and CAT5e system with software applications let you schedule and deliver rich, multimedia content to your targeted audience at any time.

### Dual Picture Mode

You can simultaneously display images from any two different kinds of AV sources connected. Or, adding one of the optional terminal boards lets you display images from two of the same type of image source, such as two PCs or two DVD players. This function allows you to take full advantage of the plasma display's large screen.

When displaying two separate images, you can select the audio output from either source. Playing back the audio from the sub-source can be useful in teleconferencing, for example.

#### Dual Picture Mode

The display mode can be switched by pressing the Multi PIP button.

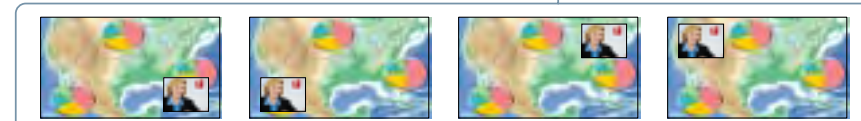

In the Picture-in-Picture display mode, the sub-screen picture can be displayed at a location where it has minimum effect on the main-screen image.

### • Advanced Dual Picture Mode — Useful in Digital Signage

Panasonic plasma displays feature the Advanced Dual Picture Mode in addition to the conventional Dual Picture Mode. This mode lets you overlay a video image onto a full-screen PC image. For example, you can superimpose text information from a PC over a video clip, giving you a more effective way to present information.

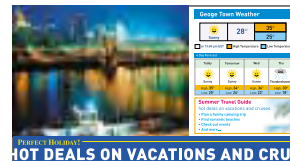

Motion images and text messages can be displayed in parallel to each other. The running text message section at the bottom can be used to display "hot topics." The large screen can be used to provide large amounts of information at the same time.



Motion images and text messages are arranged next to each other. Thanks to the simple and neat layout, motion images accentuate the entire screen.

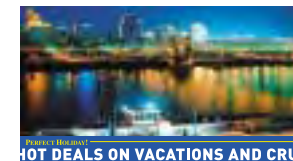

Motion images and text messages are combined. Since both the top and bottom content contains motion, they draw attention for more effective advertising.

### Weekly Command Timer

This function makes it easy to automate display operation so there's no need to use an external scheduler. You can set a variety of operations — power on/off, image source selection, screen saver functions and more — to activate at specific times on specific days of the week.



### Remote System Monitoring

In addition to the conventional display control command and power supply/input selection check command, Panasonic plasma displays feature a monitor command that lets you check the signal from a distant location. In conventional systems, you had to install a monitoring camera to check the images displayed on an advertising display panel or digital signage system. This monitor command, on the other hand, lets you monitor images by simply connecting a PC via a serial cable.

### Vertical Mounting

Panasonic professional plasma displays can be positioned vertically to display portrait images, allowing them to serve as effective storefront signboards. There's no need to install an optional fan kit.



### Enhanced Screen Saver Functions

A variety of screen saver functions help lower the risk of uneven phosphor ageing.

- White Bar Scroll: White bars move across the screen from left to right at regular intervals. Good for ordinary still-image displays.
- Screen Reversal: Displays images with the black and white reversed. Good for text displays.
- Side Panel Adjustment: Brightens the black bands on the sides of the screen when displaying images in the 4:3 format.
- Wobbling: Shifts the image's position by several pixels at fixed time intervals or according to the detected screen condition.
- Peak Limit Mode: Lowers the peak brightness level (image contrast).



# Cutting-Edge Functions for Effective Presentations



## Multi-Presentation System Using the Wireless Presentation Board

Mounting the Wireless Presentation Board to a conference display unit allows wireless connection of up to eight displays and four PCs. This is enough to show images in every area of a conference hall. It also eliminates the bothersome task of removing and reconnecting cables when using multiple PCs.

### Wireless Presentation Board (Option)

#### • No More Complicated Wiring

Simply install Wireless Manager software and change the network settings to set up your wireless network. There is no need for bothersome wiring. You can also connect up to four PCs to multiple displays for effective, interactive use by groups or for presentations.

\* This board cannot be used on the PS series..

#### • High-Speed Wireless Transmission

High-speed wireless transmission provides smooth display of video clips, animation, and other types of large-volume data. Audio tracks are sent simultaneously, enabling dynamic presentations with active images and sounds.

\* Sound is produced only when using a single, full-screen display of a single PC image.

#### • Versatile Display Methods for Impressive Presentations

The Secondary Display Transmission (wireless prompter) function lets you show presentation content on the display and a copy of your speaking notes on a PC.

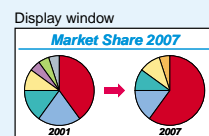

PC

You can use the Area-Specific Transmission function to display any part of the PC window that you want, or to enlarge and display certain parts for emphasis.



PC

### 4x Digital Zoom

This function lets you enlarge a portion of an image by up to four times normal size and display it on the full screen. Use this function to give your presentations greater impact.

**Note:** Digital Zoom does not work in Dual Picture mode. Images of SXGA resolution or higher from a PC or RGB source may not enlarge correctly. Some degradation occurs when images are enlarged.

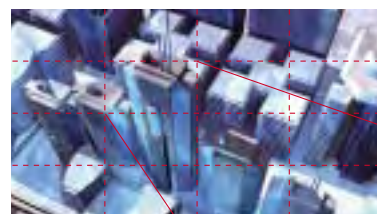

### Automatic Picture Positioning (PF series only)

This function automatically corrects the horizontal and vertical picture positions, clock phase, and dot clock when an analog RGB signal is input. The adjustment results in optimal standard values for the horizontal and vertical picture sizes.

# Advanced Functions Suitable for Use in Broadcast Stations



## HD-SDI System for Broadcast Use

The Full HD plasma model adapts easily to systems that use HD-SDI, the digital interfaces used in broadcasting and video production. Simply plug the HD-SDI terminal board into the function slot, and you get crisp, clear HD images for the studio or control room.

### Adapts Easily to HD-SDI Systems

The HD-SDI terminal board supports max. 10-bit input signals, for greater colour reproduction precision and richer gradation. With outstanding reproducibility across the entire HDTV-standard (ITU-R, BT709) colour range, Panasonic Full HD panels deliver faithful, natural-looking colours from HD sources. And because they provide full-digital signal processing from input to display, these models are suitable for use as HD master monitors.

### Monitor Multiple Sources on a Single 103-inch Screen

Connect the 103-inch model to a multi-display processor by using the DVI-D Terminal Board, and the screen can be divided into sub-screens for monitoring multiple sources. This gives you an efficient way to view different images at once.



Conventional CRT monitors



103-inch plasma displays

### Energy-Saving Functions

A broad range of environment-friendly functions help minimize energy consumption.

- DPMS (Display Power Management Signaling): Power is automatically turned on or off in response to a sync signal from the PC connected to the built-in PC input terminal.

### 1:1 Pixel Mode (PF series only)

The 1:1 Pixel mode maps the 1920 x 1080 video content to Full HD panel pixels to display 100% of the original content. By skipping the scaling process, this mode is able to produce high-definition images in their original, 1:1 pixel form.

**Note:** 1920 x 1080 PC signals are always displayed in 1:1 mode.

### Ideal as a Studio Monitor for News Programmes

By combining an HD plasma display model with a touch-panel and HD-SDI terminal board, you can construct a studio monitor system for effectively displaying meteorological information. By using the touch-panel, the weather forecaster can add handwritten information and marks to the clear image displayed on the plasma display panel. This ushers in a brand new style of easy-to-understand weather forecasts.



### Studio W/B Mode

This lets you set the colour temperature that best matches applications in broadcast stations and studios.

### Studio Gain Mode

This mode increases the contrast to eliminate whiteout.

- Auto Power Off: When you're using a device connected to the multi-function slots, the display panel goes into standby mode after about 10 minutes if no sync signal is received.
- Power Save Mode: Reduces the display's brightness.
- Standby Power Save Mode: Reduces power consumption when on standby. (Start-up may take a few moments once the display is in this mode.)



# Industry's Best Expandability

## Multi-Function Slots

In addition to the fixed input interface, the Panasonic plasma display has three interchangeable slots that let you add different combinations of optional terminal boards. This gives you the flexibility to add digital or analog capabilities, as necessary, and to customize your system for specific needs.



## Standard-Equipped Terminals

You can mount optional terminal board in a vacant slot. Or, you can remove the standard terminal boards and mount optional boards.

TH-103PF10TK  
TH-65PF10TK



TH-58PH10TK  
TH-50PH10TK/TS  
TH-42PH10TS  
TH-42PS10TK/TS



## Optional Terminal Boards

Dual HDMI Terminal Board  
(mounts in slot 1 or 2)

**TY-FB10HMD**



HDMI Terminal Board  
(mounts in slot 1 or 2)

**TY-FB8HM**



### Specifications

	TY-FB10HMD	TY-FB8HM
Interface	HDMI Type-A x 2	HDMI Type-A
Compatible video format	525/60p, 625/50p, 750/60p, 750/50p, 1125/60i, 1125/50i, VGA60, 1125/60p (PF series only), 1125/50p (PF series only), 1125/24p (PF series only)	525/60p, 625/50p, 750/60p, 750/50p, 1125/60i, 1125/50i, VGA60
Compatible audio format	Linear PCM (Sampling frequency: 48/44.1/32 kHz)	
Applicable displays	PF and PH series	PF, PH and PS series

\* High-Definition Multimedia Interface and HDMI are trademarks of HDMI Licensing, LLC.

- Enables fully digital connection of signals from HDMI-compatible DVD players and other digital equipment for blur-free images with no colour bleeding.
- Provides simultaneous video and audio signal transmission using a single cable.

RGB Active Through Terminal Board  
(mounts in slots 1 & 2)

**TY-42TM6G**



- Sends the signal that's input via the PC IN terminal to a second display connected to the PC OUT terminal. This connectability adds convenience when configuring a multi-screen system.

The characters in red are added for explanation.

DVI-D Terminal Board  
(mounts in slot 1 or 2)

**TY-FB9FDD** (for PF series)  
**TY-42TM6D** (for PH/PS series)



- Lets you connect a PC or other compatible digital equipment that outputs digital RGB signals (DVI-D compliant).
- Supports HDCP.
- TY-FB9FDD is compatible with UXGA/WUXGA signals (compressed display).

Ir Through Terminal Board  
(mounts in any slot)

**TY-FB9RT**



Note: Only one terminal board can be used per display. Also, it can be used to control only Panasonic AV equipments.

PC Input Terminal Board  
(mounts in any slot)

**TY-42TM6P**



- Lets you display images from two or more PCs.

\* Does not support the DPMS function.

BNC Dual Video Terminal Board  
(mounts in slot 1 or 2)

**TY-FB9BD**



Composite/Component Video Terminal Board  
(mounts in slots 1 & 2, or slots 2 & 3)

**TY-42TM6Y**

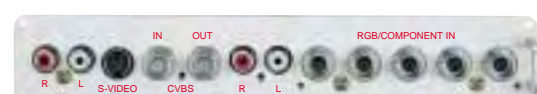

BNC Component Video Terminal Board  
(mounts in any slot)

**TY-42TM6A**

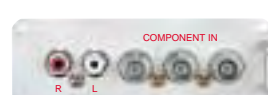

RCA Component Video Terminal Board  
(mounts in any slot)

**TY-42TM6Z**



BNC Composite Video Terminal Board  
(mounts in slot 1 or 2)

**TY-42TM6B**



RCA Composite Video Terminal Board  
(mounts in slot 1 or 2)

**TY-42TM6V**



SDI/HD-SDI Terminal Board (mounts in slot 1 or 2)

HD-SDI Terminal Board with Audio **TY-FB10HD**

HD-SDI Terminal Board **TY-FB9HD**

SDI Terminal Board **TY-FB7SD**

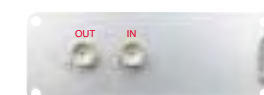

- Supports the serial digital interface (SDI) used in broadcasting.
- The TY-FB10HD provides simultaneous video and audio signal transmission using a single cable.
- The TY-FB10HD and TY-FB9HD support HDTV.

### Specifications

	TY-FB10HD	TY-FB9HD	TY-FB7SD
Standards compliance	SMPTE292M, SMPTE259M-C		
Compatible video format	525/59.94i, 625/50i, 750/60p, 59.94p, 750/50p, 1125/30p, 1125/25p, 1125/24p, 1125/60i, 1125/50i, 1125/24sF, 23.98psF		525/59.94i, 625/50i
Applicable displays	PF series	PF, PH and PS series	

Wireless Presentation Board (mounts in slots 1 & 2, or slots 2 & 3)

**TY-FB10WPU**

Applicable models: PF and PH series

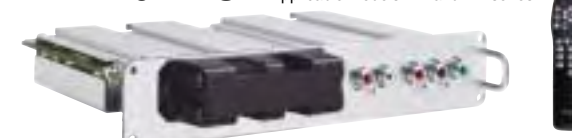

- Wireless connection (IEEE 802.11b/11g) eliminates the need to connect any cables between the display and a PC.
- High-speed wireless transmission produces smooth motion images.
- Images from one PC can be displayed in real-time on as many as eight displays.
- Images from up to 16 PCs can be simultaneously displayed onto a single screen.
- Plasma displays can be controlled using a Web browser.
- The Wireless Presentation Board also accepts component video and audio inputs.

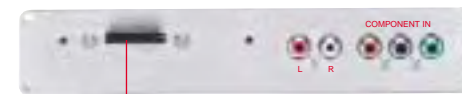

Wireless Card (A protective cover is included for wireless card use.)

### Specifications

Standards compliance	IEEE 802.11b/11g
Frequency range	2.4 GHz
<b>System Configuration Required by Wireless Manager ME 4.0</b>	
OS	Microsoft Windows 2000 Professional/XP Home Edition/XP Professional
CPU	Intel Pentium III 600 MHz or faster (or compatible processor) (Processing speed of 800 MHz or faster recommended for Live mode)
Memory	256 MB or more
HDD	60 MB or more of available disk space
Required hardware	• CD or DVD drive (for installing software and browsing the instruction manual) • A correctly operating built-in wireless LAN function or external wireless LAN adaptor supporting IEEE 802.11b/g
Web browser	Microsoft Internet Explorer 6.0 or newer, Netscape Communicator 7.0 or newer

\* Microsoft, Windows and PowerPoint are either trademarks or registered trademarks of Microsoft Corporation in the United States and/or other countries. Intel and Pentium are either trademarks or registered trademarks of Intel Corporation in the United States and/or other countries.

## Main Functions

- Live Mode**  
Images from one PC can be shown in real-time over the entire display.
- Multi-Display Live Mode**  
Images from one PC can be sent by wireless transmission to as many as eight displays in real-time.



Up to four PCs can be used.

- Multi-Live Mode**  
Images from up to 16 PCs can be shown together, in real-time, on the same display. (This can also be combined with Multi-Display Live mode.)

- 4-Window Multi Style**  
The display screen is divided into four windows, and images from up to four PCs can be simultaneously displayed.
- 4-Window Index Style**  
Images from up to four PCs are shown in thumbnail form at the bottom of the display. The operator can use the remote control to enlarge any of the images.
- 16-Window Index Style**  
Images from up to 16 PCs are shown in thumbnail form on the display. The operator can use the remote control to enlarge any of the images.

- Secondary Display Transmission**  
This function transmits a secondary window from the PC. For example, it lets you display the Notes window from Microsoft PowerPoint onto your PC screen while showing the corresponding Slide Show on the display.

- Area-Specific Transmission**  
Enlarges and displays only desired parts of the PC screen.

- Web Browser Control**  
This function lets you control the display from your Web browser, for operations such as power on/off, input selection, and sound volume adjustment.

## Optional AV Terminal Box

**TY-TB10AV**



- Ideal for hotel guest rooms. Two input terminals (VIDEO/RGB) allow guests to easily connect and use their own notebook PC, portable DVD player, or other device.
- The TY-TB10AV can also be built into a desk or a bed sideboard.

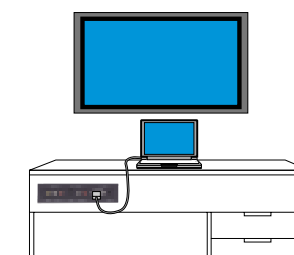

### Front Panel





# Peripherals

Note: Specifications of peripherals on this page are subject to change without notice.

## PDP Controller

### ETX-1312C Series (Mounts in slots 1 & 2)

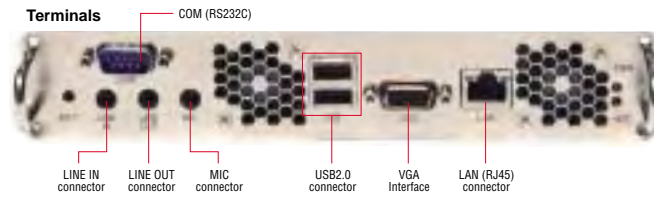

- Compact plug-in PC to facilitate turnkey solutions.
- Does not require any external power sources or any external brackets.
- Ease of use.
- Supports Compact Flash Cards.
- Supports VGA Display.

#### Specifications

Model number	ETX-1312C1000	ETX-1312C600	ETX-1312C1000-XPE	ETX-1312C600-XPE
Slot compatibility	requires slots 1 to 2			
Processor	ULV Pentium Celeron 1 GHz	ULV Pentium Celeron 600 MHz	ULV Pentium Celeron 1 GHz	ULV Pentium Celeron 600 MHz
Memory	512 MB RAM (DDR SO-DIMM)			
Internal HDD	40 GB HDD (2.5" HD)			
Interfaces	1 x LAN, 2 x USB 2.0, 1 x Serial, 1 x Line In/Out, 1 x Mic In			
VGA output	Yes			
Pre-installed OS	—			Windows XP Embedded
PXE and wake-on-LAN-capable	Yes			
Dimensions (W x H x D)	203 x 32 x 125 mm			
Power supply	Supplied from the plasma display			
Standards	FCC, CE, RoHS			

For the latest information on the ETX-1312C Series:

**EINS TECHNOLOGY PTE LTD**  
 TEL:+65 6440 1811  
 FAX:+65 6440 2792  
 Website: www.einstech.com

## Touch Panel



### Touch Panel (CMOS Camera Detection System)

- TY-TP65P10S** (for TH-65PF10TK)
- TY-TP58P10S** (for TH-58PH10TK)
- TY-TP50P10S** (for TH-50PF10/50PH10 series)
- TY-TP42P10S** (for TH-42PH10/42PS10 series)

- High resolution
- High scan speed
- Dividable frame system for compact packaging

Note: You cannot use the TY-ST08-K/S pedestal for these touch panels.

### Touch Panel (Optical Disturbance Detection System)

- TY-TP50P8-S** (for TH-50PF10/50PH10 series)
- TY-TP42P8-S** (for TH-42PH10/42PS10 series)

- Use of highly reliable optical sensors
- Thin profile for a perfect screen fit
- Attractive design for portrait positioning

Note: The touch panel does not include a drawing application. You cannot mount both a TY-TP65P10S, TP58P10S, TP50P8-S, or TP42P8-S Touch Panel and an Anti-Glare Filter at the same time.

## Digital Signage/Narrowcasting System

Easy, interactive content distribution system for retail chains and public spaces such as shopping malls, office buildings and hotels.

### • Constructing a Multi-Language Environment

In contrast with conventional methods, in which several information panels are prepared in different languages, this digital system allows visitors to simply touch the panel itself to switch to the language they want. It is a highly effective and efficient way to offer people the content that they want to see.

### • Flexible Content Control

Each PC connected to the Plasma has a unique IP address, allowing content to be streamed to the Plasma on any LAN, modem, Internet or Satellite network. It speeds up the process of updating information, and any combination of Plasmas can be controlled locally or from a central location.

### • Space-Saving and Easy to install

We have slimmed down the display system by incorporating the optional PDP Controller right inside the plasma display. It requires only two connections, power and network.

### • Universal System Design

Since the entire system can be configured in a Windows environment, it requires no special software for content production or operation.

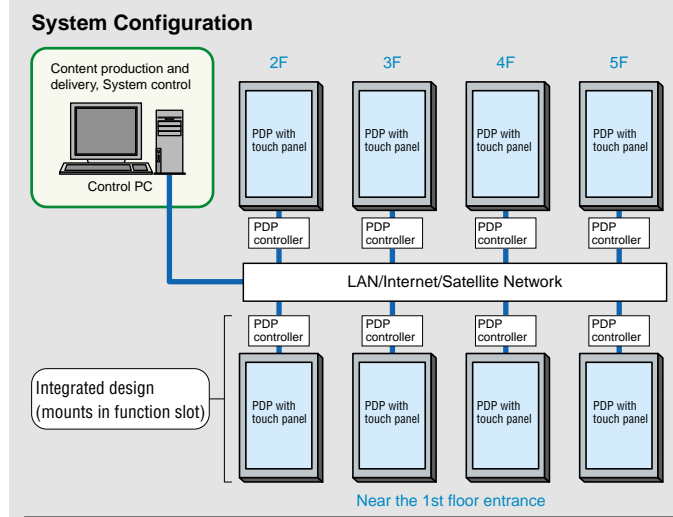

\* You can configure 50-inch displays and control system by simply combining Panasonic 50-inch Plasma Display and the Touch Panel, then mounting the PDP Controller in the function slot of the plasma display.

\* Content is distributed by a centralized control PC in an office and stored in the hard disk of each PDP controller, ready to be displayed by touch panel operation.



## Effective Interactive System

Function slots make it possible to combine various types of video equipment into an interactive system capable of reproducing a wide range of visual materials. Using the Ir Through Terminal Board, the video equipment can be operated by remote control while it is stored in racks to keep the room neat and tidy. The touch panel adds to the persuasive power of presentations and explanations. This system is ideal for seminar rooms, meeting rooms, or small lecture halls.

### • Supports a Wide Variety of Video Sources

The BNC Dual Video Terminal Board and Component Video Terminal Board enable connection to various video devices. You can display images from VCRs, S-VHS VCRs, DVD players, and more.

### • Keeps the Room Neat and Attractive

The video devices can be connected to the Ir Through Terminal Board and placed out of the way in racks. Each device can then be operated via the remote control sensor on the display. You can even close the rack doors to keep the room interior neat and uncluttered for more comfortable discussions.

### • Clear Visual Communications

With the touch panel, you can write comments directly onto the screen. Make your meetings more precise by clearly notating the materials displayed on-screen.

**The touch panel clearly drives your points across!**

Sales dropped like this from March to May, but we also have to consider the increase that you can see here in June and July.

With words alone, it is often difficult for your audience to grasp the main points you are trying to communicate, which sometimes leads to confusion.

The touch panel lets you emphasise the main points, so your audience is left with a clear and precise explanation.

Note: The touch panel does not include a drawing application.

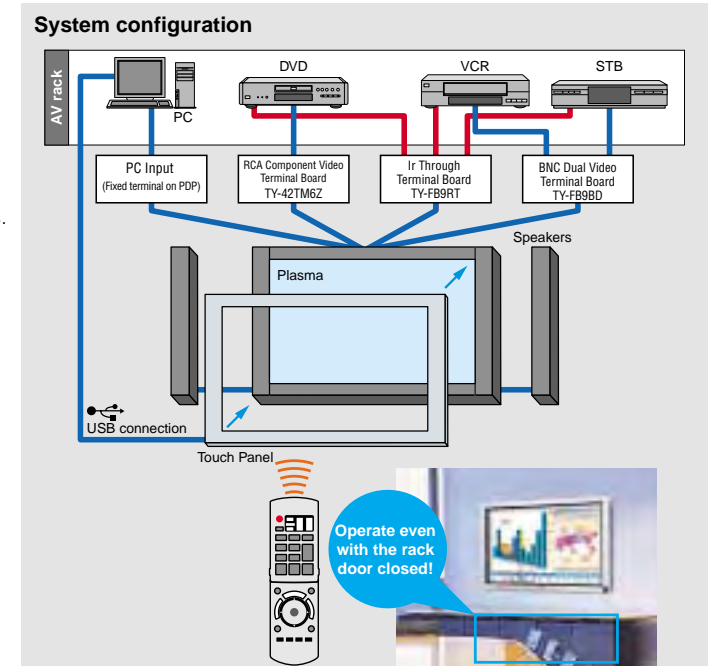



# An Endless Array of Applications

## DIGITAL SIGNAGE



Shopping Mall, Budapest, Hungary



Grand Century, Hong Kong, China



Rica Maritim Hotel, Norway  
[www.rica.no](http://www.rica.no)  
[www.visithaugalandet.no](http://www.visithaugalandet.no)



Golden Harvest Hollywood, Hong Kong, China

## TV PRODUCTION



103 plasma in CBS's "Early Show" studio, New York, USA



 ČESKÁ TELEVIZE's studio, Czech

## AMUSEMENT



Dolphin Stadium, Miami, USA



Planet Hollywood Resort, Las Vegas, USA

## PASSENGER INFORMATION



Kansai International Airport, Osaka, Japan



Minatomirai Station, Yokohama, Japan

## CONTROL ROOM



Vatican Museum

## TRADE SHOW



Volvo booth at Automobile exhibition, Sweden



## Full HD Models



**TH-103PF10TK**  
103-inch (260 cm) diagonal  
Full High Definition Plasma Display



**TH-65PF10TK**  
65-inch (165 cm) diagonal  
Full High Definition Plasma Display



## HD Models



**TH-58PH10TK**  
58-inch (148 cm) diagonal  
High Definition Plasma Display



**TH-50PH10TK**  
**TH-50PH10TS**  
50-inch (127 cm) diagonal  
High Definition Plasma Display

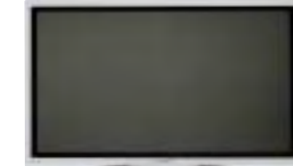

**TH-42PH10TS**  
42-inch (106 cm) diagonal  
High Definition Plasma Display



**TH-42PS10TK**  
**TH-42PS10TS**  
42-inch (106 cm) diagonal  
Progressive Wide Plasma Display

## Specifications

Commodity Name	103" HD Plasma Display	65" HD Plasma Display
Model Number	TH-103PF10TK	TH-65PF10TK
Cabinet Color	Black	Black
<b>DISPLAY</b>		
Screen Size (Diagonal)	103-inch	65-inch
Aspect Ratio	16:9	16:9
Effective Display Area (W x H)	2,269 x 1,277 mm	1,434 x 807 mm
Resolution (H x V)	1,920 x 1,080 pixels	1,920 x 1,080 pixels
Pixel Pitch (H x V)	1.182 x 1.182 mm	0.747 x 0.747 mm
Contrast Ratio	5,000:1	10,000:1
Gradation	4,096 steps (equivalent)	4,096 steps (equivalent)
<b>SIGNAL COMPATIBILITY</b>		
Scan Rate	Horizontal frequency: 15 — 110 kHz; Vertical frequency: 48 — 120 Hz	
PC Signal Compatibility	VGA, WVGA, SVGA, XGA, WXGA, WXGA+, SXGA, SXGA+, WSXGA+, UXGA, WUXGA (UXGA and over resolution: compressed)	
Supported Video Standards	NTSC, PAL, PAL 60, SECAM, Modified NTSC	
Video Signal Compatibility	525 (480)/60i, 60p; 625 (575)/50i, 50p; 750 (720)/60p, 50p; 1125 (1080)/60i, 50i, 24p, 24sF, 25p, 30p, 60p, 50p; 1250 (1080)/50i	
<b>INPUT/OUTPUT</b>		
Fixed Terminals		
PC IN	Mini D-sub 15pin x 1; Analog RGB/Component; Plug & Play (VESA DDC 2B)	
AUDIO IN	M3 jack x 1	
SERIAL	D-sub 9-pin x 1, External control, RS-232C compatible	
Interchangeable Terminals		
Slot1	Vacant	Vacant
Slot2	HDMI In x 2	
Slot3	Component In (BNC x 3, Analog RGB/Component), Audio In (L/R) (RCA pin jack x 2)	
<b>ELECTRICAL</b>		
Power Requirements	220 - 240 V AC, 50 Hz/60 Hz	110 V AC, 50 Hz/60 Hz
Power Consumption	1,500 W	725 W
Power off condition	0.5 W	0.3 W
Stand-by condition	Save Off: 1.0 W, Save On: 0.9 W	Save Off: 0.7 W, Save On: 0.5 W
<b>SOUND</b>		
Audio Output	Line Out (L/R)	20 W [10 W + 10 W] (10 % THD)
<b>MECHANICAL</b>		
Dimensions (W x H x D <sup>1</sup> )	2,414 x 1,421 x 129 mm	1,554 x 925 x 99 mm
Weight (approx.)	220.0 kg	72.0 kg
<b>OPERATING ENVIRONMENT</b>		
Temperature	0°C — 40°C	
Humidity	20% — 80% (Non condensation)	
Altitude	0 - 2,400 m	0 - 2,800 m
<b>RADIATION REGULATIONS</b>		
	CNS13439	
<b>SAFETY STANDARDS</b>		
	CNS14408	

\*1: Exclusive of protruding portion

Commodity Name	58" HD Plasma Display	50" HD Plasma Display		42" HD Plasma Display	42" SD Plasma Display	
Model Number	TH-58PH10TK	TH-50PH10TK	TH-50PH10TS	TH-42PH10TS	TH-42PS10TK	TH-42PS10TS
Cabinet Colour	Black	Black	Silver	Silver	Black	Silver
<b>DISPLAY</b>						
Screen Size (Diagonal)	58-inch	50-inch		42-inch	42-inch	
Aspect Ratio	16:9	16:9		16:9	16:9	
Effective Display Area (W x H)	1,287 x 723 mm	1,106 x 622 mm		922 x 518 mm	920 x 518 mm	
Resolution (H x V)	1,366 x 768 pixels	1,366 x 768 pixels		1,024 x 768 pixels	852 x 480 pixels	
Pixel Pitch (H x V)	0.942 x 0.942 mm	0.810 x 0.810 mm		0.900 x 0.675 mm	1.080 x 1.080 mm	
Contrast Ratio	10,000 : 1					
Gradation	3,072 steps (equivalent)					
<b>SIGNAL COMPATIBILITY</b>						
Scan Rate	Horizontal frequency: 15 — 110 kHz; Vertical frequency: 48 — 120 Hz					
PC Signal Compatibility	VGA, WVGA, SVGA, XGA, WXGA, WXGA+, SXGA, SXGA+, WSXGA+, UXGA, WUXGA (WXGA+ and over resolution: compressed) (WXGA and over resolution: compressed) (SVGA and over resolution: compressed)					
Supported Video Standards	NTSC, PAL, PAL 60, SECAM, Modified NTSC					
Video Signal Compatibility	525 (480)/60i, 60p; 625 (575)/50i, 50p; 750 (720)/60p, 50p; 1125 (1080)/60i, 50i, 24p, 24sF, 25p, 30p... 1250 (1080)/50i					
<b>INPUT/OUTPUT</b>						
Fixed Terminals						
PC IN	Mini D-sub 15pin x 1; Analogue RGB/Component; Plug & Play (VESA DDC 2B)					
AUDIO IN	M3 jack x 1					
SERIAL	D-sub 9-pin x 1, External control, RS-232C compatible					
Interchangeable Terminals						
Slot1	CVBS In (BNC x 1, Composite), Audio In (L/R) (RCA pin jack x 2); S-Video In (S-Video x 1), Audio In (L/R) (RCA pin jack x 2)					
Slot2	Vacant	Vacant	Vacant	Vacant	Vacant	
Slot3	Vacant	Vacant	Vacant	Vacant	Vacant	
<b>ELECTRICAL</b>						
Power Requirements	110 V AC, 50 Hz/60 Hz	110 V AC, 50 Hz/60 Hz	110 V AC, 50 Hz/60 Hz	110 V AC, 50 Hz/60 Hz	110 V AC, 50 Hz/60 Hz	
Power Consumption	630 W	485 W	485 W	365 W	280 W	
Power off condition	0.1 W	0.1 W	0.1 W	0.2 W	0.1 W	
Stand-by condition	Save Off: 0.6 W, Save On: 0.4 W	Save Off: 0.6 W, Save On: 0.4 W	Save Off: 0.6 W, Save On: 0.4 W	Save Off: 0.7 W, Save On: 0.5 W	Save Off: 0.6 W, Save On: 0.5 W	
<b>SOUND</b>						
Audio Output	16 W [8 W + 8 W] (10 % THD)					
<b>MECHANICAL</b>						
Dimensions (W x H x D <sup>1</sup> )	1,399 x 843 x 99 mm	1,210 x 724 x 95 mm	1,020 x 610 x 89 mm	1,020 x 610 x 89 mm	1,020 x 610 x 89 mm	
Weight (approx.)	54.0 kg	36.0 kg	26.0 kg	26.0 kg	26.0 kg	
<b>OPERATING ENVIRONMENT</b>						
Temperature	0°C — 40°C					
Humidity	20% — 80% (Non condensation)					
Altitude	0 — 2,800 m			0 — 3,000 m		
<b>RADIATION REGULATIONS</b>						
	CNS13439					
<b>SAFETY STANDARDS</b>						
	CNS14408					

\*1: Exclusive of protruding portion



# Dimensions

# Preset Input Signals

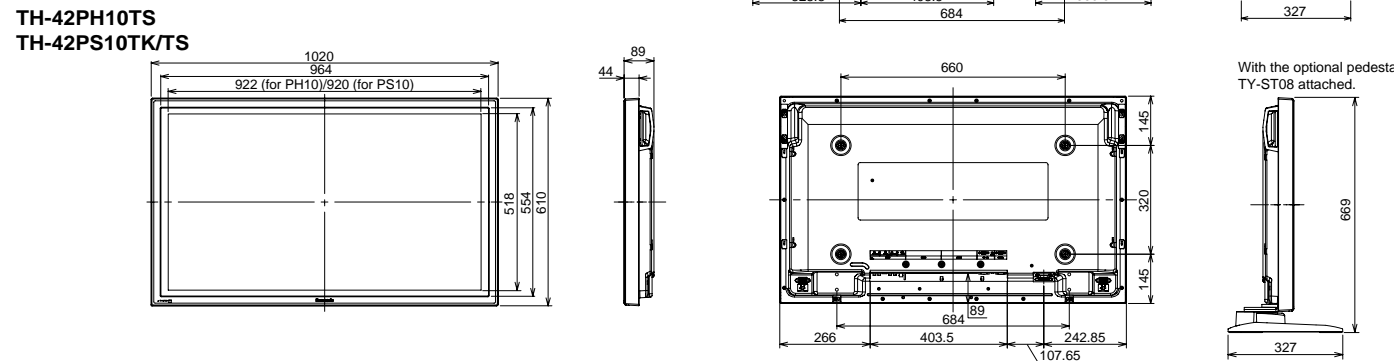
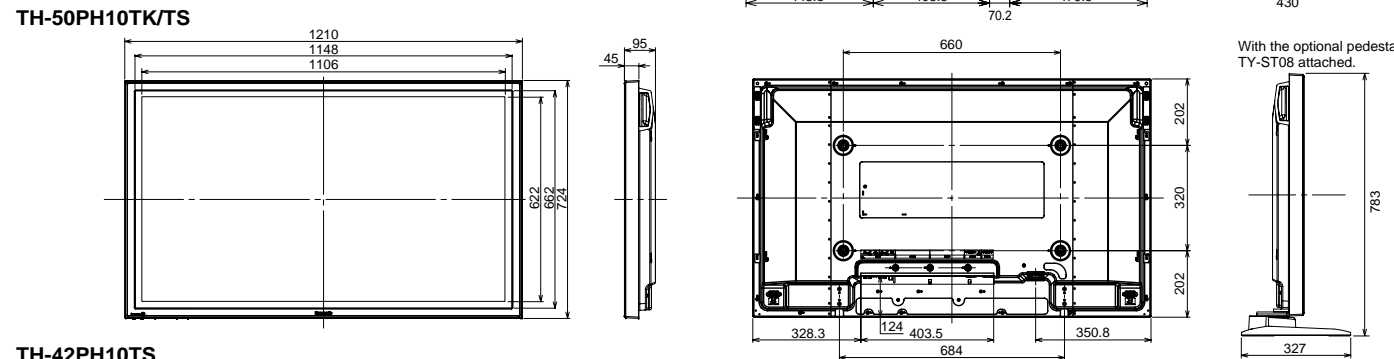
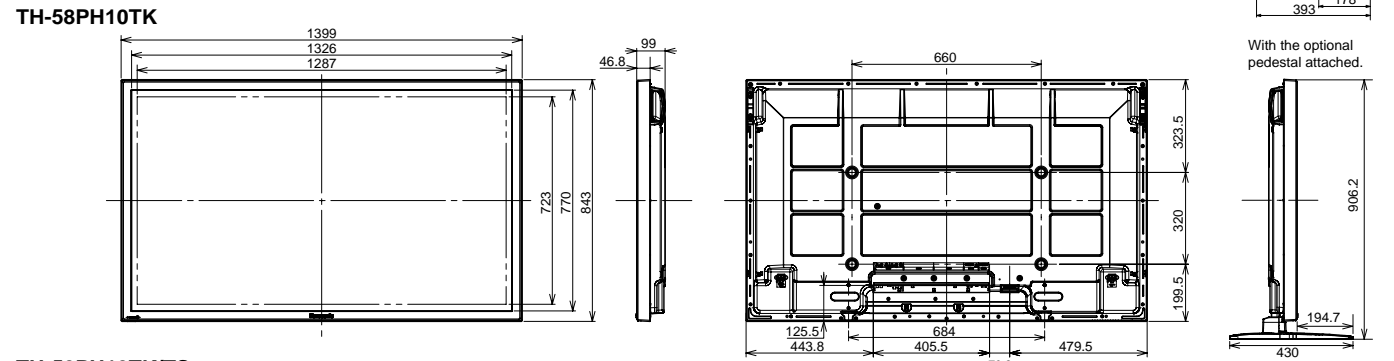
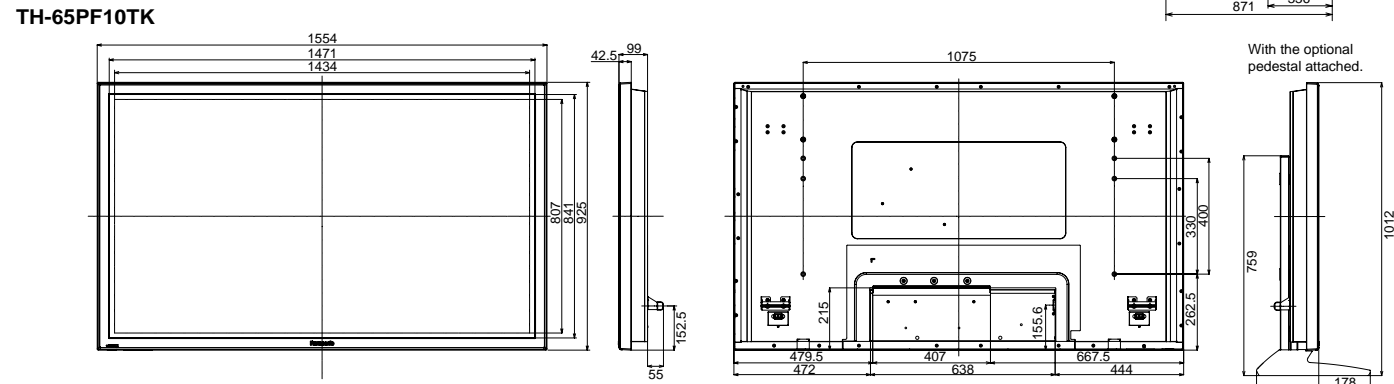
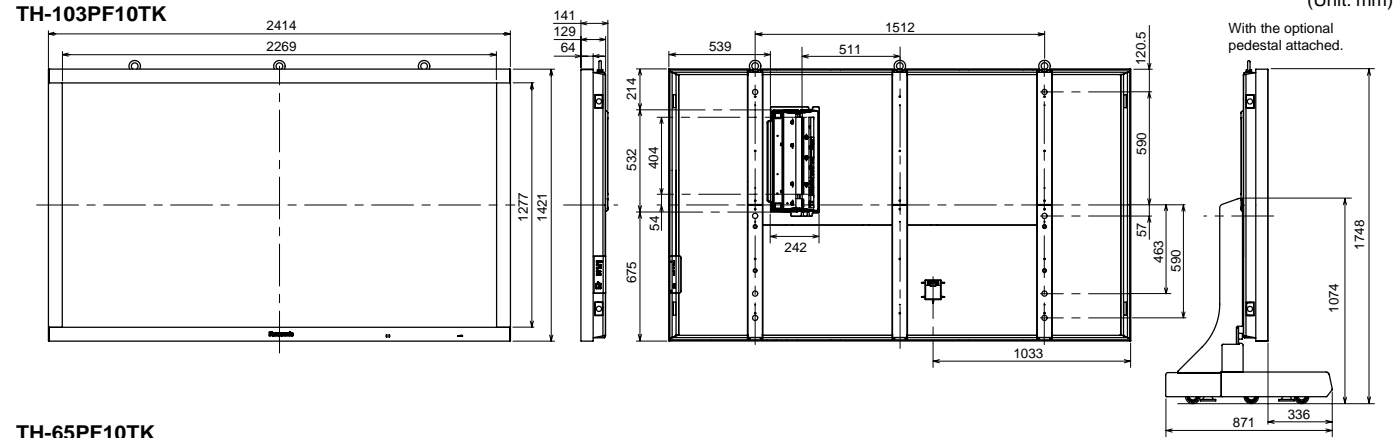

## Preset Input Signals

Signal name	Horizontal Frequency (kHz)	Vertical Frequency (Hz)	Optional Terminal Board											Dot Clock (MHz)				
			Composite Video TY-42TM6Y	Component Video TY-42TM6AZ	PC Input TY-42TM6P	RGB Active Through TY-42TM6G	Composite Video TY-42TM66V	BNC Dual Video TY-FB98D	DVI-D TY-FB9FD	DVI-D TY-42TM6D	SD TY-FB7SD	HD-SDI TY-FB9HD	HD-SDI with Audio TY-FB10HD	HDMI TY-FB8HM	Dual HDMI TY-FB10HMD	PC In (D-sub 15-pin) Fixed Terminal	Component RGB In/PC In	DVI-D In
<b>Composite</b>																		
NTSC	15.73	59.94	Y															
PAL	15.63	50.00	Y															
PAL60	15.73	59.94	Y															
SECAM	15.63	50.00	Y															
Modified NTSC	15.73	59.94	Y															
525 (480)/60i	15.73	59.94	Y	Y	Y	Y	Y										13.5	
525 (480)/60p	31.47	59.94	Y	Y	Y	Y	Y										27.0 (*2)	27.0
625 (575)/50i	15.63	50.00	Y	Y	Y	Y	Y										13.5	
625 (575)/50p	31.25	50.00	Y	Y	Y	Y	Y										27.0	
625 (576)/50p	31.25	50.00																
750 (720)/60p	45.00	60.00	Y	Y	Y	Y	Y										74.25	74.25
750 (720)/50p	37.50	50.00	Y	Y	Y	Y	Y										74.25	74.25
1125 (1080)/60i	33.75	60.00	Y	Y	Y	Y	Y										74.25	74.25
1125 (1080)/60p	67.50	60.00	Y (*1)	Y (*1)	Y (*1)	Y (*1)											148.5	148.5
1125 (1080)/50i	28.13	50.00	Y	Y	Y	Y											74.25	74.25
1125 (1080)/50p	56.25	50.00	Y (*1)	Y (*1)	Y (*1)	Y (*1)											148.5	148.5
1125 (1080)/30p	33.75	30.00	Y	Y	Y	Y											74.25	
1125 (1080)/25p	28.13	25.00	Y	Y	Y	Y											74.25	
1125 (1080)/24p	27.00	24.00	Y	Y	Y	Y											74.25	
1125 (1080)/24sF	27.00	48.00	Y	Y	Y	Y											74.25	
1250 (1080)/50i	31.25	50.00	Y	Y	Y	Y											74.25	
640 x 400 @70Hz	31.46	70.07	Y	Y	Y	Y											25.17	
640 x 480 @60Hz	31.47	59.94	Y	Y	Y	Y											25.18 (*3)	25.18
640 x 480 @72Hz	37.86	72.81	Y	Y	Y	Y											31.5	
640 x 480 @75Hz	37.50	75.00	Y	Y	Y	Y											31.5	
640 x 480 @85Hz	43.27	85.01	Y	Y	Y	Y											36.0	
800 x 600 @56Hz	35.16	56.25	Y	Y	Y	Y											36.0	
800 x 600 @60Hz	37.88	60.32	Y	Y	Y	Y											40.0	40.0
800 x 600 @72Hz	48.08	72.19	Y	Y	Y	Y											50.0	
800 x 600 @75Hz	46.88	75.00	Y	Y	Y	Y											49.5	
800 x 600 @85Hz	53.67	85.06	Y	Y	Y	Y											56.25	
852 x 480 @60Hz	31.47	59.94	Y	Y	Y	Y											33.54 (*3)	34.24
1024 x 768 @50Hz	39.55	50.00																51.89
1024 x 768 @60Hz	48.36	60.00	Y	Y	Y	Y											65.0	65.0
1024 x 768 @70Hz	56.48	70.07	Y	Y	Y	Y											75.0	
1024 x 768 @75Hz	60.02	75.03	Y	Y	Y	Y											78.75	
1024 x 768 @85Hz	68.68	85.00	Y	Y	Y	Y											94.5	
1066 x 600 @60Hz	37.64	59.94	Y	Y	Y	Y											53.0	53.0
1152 x 864 @60Hz	53.70	60.00																81.62
1152 x 864 @75Hz	67.50	75.00	Y	Y	Y	Y											108.0	
1280 x 960 @60Hz	60.00	60.00	Y	Y	Y	Y											108.0	
1280 x 960 @85Hz	85.94	85.00	Y	Y	Y	Y											148.5	
1280 x 1024 @60Hz	63.98	60.02	Y	Y	Y	Y											108.0	108.0
1280 x 1024 @75Hz	79.98	75.03	Y	Y	Y	Y											135.0	
1280 x 1024 @85Hz	91.15	85.02	Y	Y	Y	Y											157.5	
1366 x 768 @50Hz	39.55	50.00																69.92
1366 x 768 @60Hz	48.36	60.00	Y	Y	Y	Y											86.71	87.44
1400 x 1050 @60Hz	65.22	60.00																122.61
1600 x 1200 @60Hz	75.00	60.00	Y	Y	Y	Y											162.0	162.0
1600 x 1200 @65Hz	81.25	65.00	Y	Y	Y	Y											175.5	
1920 x 1080 @60Hz	67.50	60.00	Y (*1)	Y (*1)	Y (*1)	Y (*1)											148.5	148.5
1920 x 1200 @60Hz	74.04	59.95																154.0
Mac 13 (640 x 480)	35.00	66.67	Y	Y	Y	Y											30.24	
Mac 16 (832 x 624)	49.72	74.54	Y	Y	Y	Y											57.28	
Mac 21 (1152 x 870)	68.68	75.06	Y	Y	Y	Y											100.0	

\*1: The PH/PS series does not accept these signals.  
 \*2: When selected the RGB format and 525p signal input to the Mini D-sub 15P terminal, it is recognized as VGA 60 Hz signal.  
 \*3: When inputted VGA 60 Hz format signal from the other than Mini D-sub 15P terminal, it is recognized as 525p signal.  
**Note:** When a signal having a resolution that exceeds the panel resolution is input, a simplified display will be produced.

## Serial RS232C: D-Sub 9-Pin (Male)

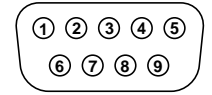

### Pin Assignment and Signal Name

Pin No.	Signal name	Descriptions
1	CD	NC
2	RXD	Receive Data
3	TXD	Transmit Data
4	DTR	Not used
5	GND	Ground
6	DSR	Not used
7	RTS	Short Circuit
8	CTS	
9	RI	NC

### Communication Parameters

Signal Level	Complied with RS232C
Synchronization Method	Asynchronous
Baud Rate	9600 bps
Parity	None
Character Length	8 bits
Stop Bit	1 bit
Flow Control	—

## PC Input: D-Sub 15-Pin (Female)

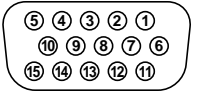

### Signal Name

Pin No.	Signal name	Pin No.	Signal name
1	R (Pr/Cr)	9	+5V DC
2	G (Y)	10	GND (Ground)
3	B (Ps/Cs)	11	NC (Not connected)
4	NC (Not connected)	12	SDA
5	GND (Ground)	13	HD/SYNC
6	GND (Ground)	14	VD
7	GND (Ground)	15	SCL
8	GND (Ground)		

## Supplied Remote Control

(Comes with every Panasonic Plasma Display model.)



### Remote Control Functions

- Power On
- Power Off
- Direct Input Selection (1/2/3/PC)
- Input Selection
- Status
- Surround On/Off
- Sound Mute On/Off
- Volume Up/Down
- Normalization (N)
- Exit (R)
- Position/Action
- Digital Zoom
- Dual Picture
- (MULTI PIP/SWAP/SELECT/MOVE)
- Picture
- Sound
- Set Up
- Picture Position/Size
- Aspect
- PC Mode Selection
- Off Timer
- Normal/ID Remote Selection
- ID Number Set
- ID All



# Options

## Wall-hanging bracket

TY-WK103PV9

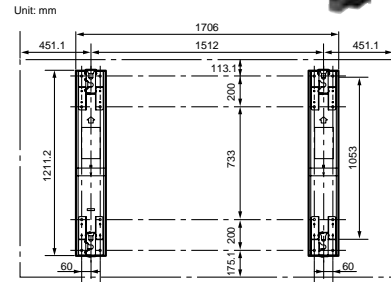

TY-WK65PV7

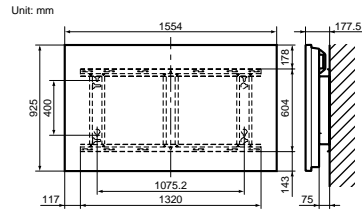
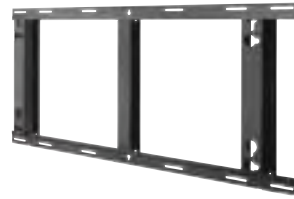

TY-WK42PV7

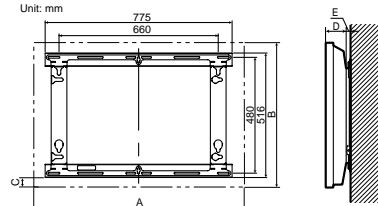

	58" model	50" model	42" model
A	1399	1210	1020
B	843	724	610
C	89	91.5	84.5
D	99	95	89
E	27.4	20	20

## Wall-hanging bracket (angled)

TY-WK65PR8

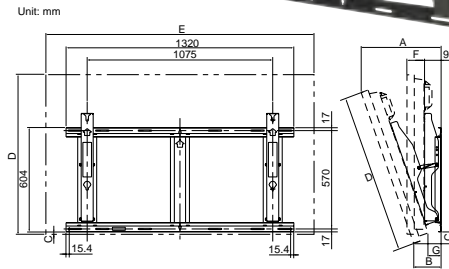

R	0°	5°	10°	15°	20°
A	186	210	240	268	293
B	198	190	180	169	158
C	14	28	41	54	66
D	925				
E	1554				
F	99				
G	99	93	87	81	74

TY-WK42PR7

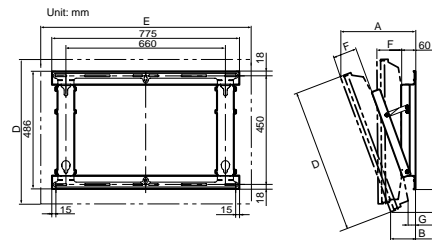

R	0°	5°	10°	15°	20°
A	167	222	275	327	376
B	167	150	132	113	93
C	128	137	146	153	158
D					843
E					1399
F					99
G	60	56	42	27	12

R	0°	5°	10°	15°	20°
A	155	200	243	285	325
B	155	137	119	99	80
C	130	137	145	152	156
D					724
E					1210
F					95
G	60	57	42	26	11

R	0°	5°	10°	15°	20°
A	145	198	226	264	299
B	149	135	121	107	92
C	73	80	88	95	101
D					610
E					1030
F					89
G	60	50	40	29	19

## Wall-hanging bracket (drawer type)

TY-WK42DR1

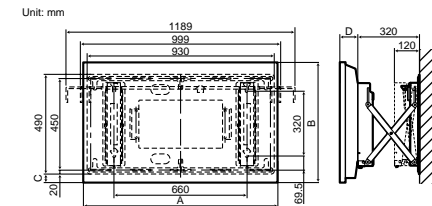

	50" model	42" model
A	1210	1020
B	724	610
C	112.5	84.5
D	95	89

### Compatible Models at a Glance

	TY-ST103PF9	TY-ST65-K	TY-ST58-K	TY-ST07-K/S	TY-ST08-K/S	TY-WK103PV9	TY-WK65PV7	TY-WK42PV7	TY-WK65PR8	TY-WK42PR7	TY-WK42DR1	TY-ST58PF10	TY-CE42PS7
TH-103PF10TK	●	—	—	—	—	●	—	—	—	—	—	—	—
TH-65PF10TK	—	●	—	—	—	—	●	—	—	—	—	—	—
TH-58PH10TK	—	—	●	—	—	—	—	●	—	—	—	●	—
TH-50PH10TK/TS	—	—	—	●	●	—	—	—	—	—	●	●	●
TH-42PH10TS, 42PS10TK/TS	—	—	—	●	●	—	—	—	—	—	●	●	●

●: Compatible; —: Not compatible

## Pedestal

TY-ST103PF9

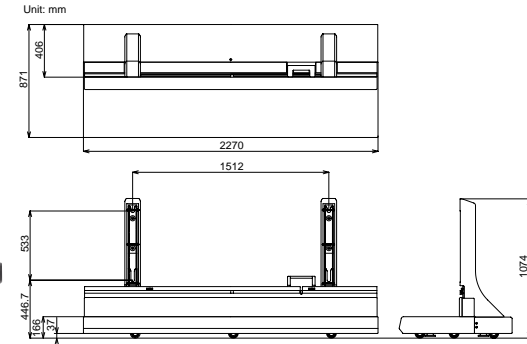

TY-ST65-K

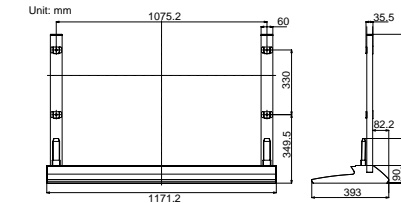

TY-ST58-K

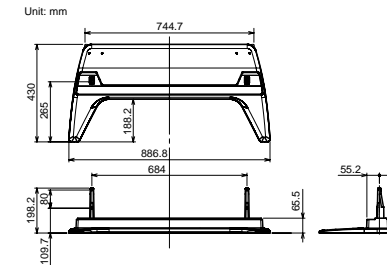

TY-ST07-K/S

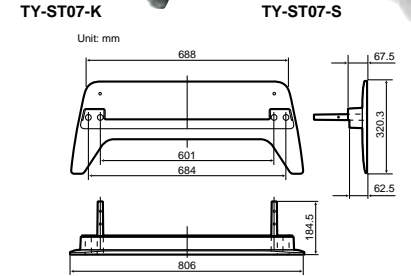

TY-ST08-K/S

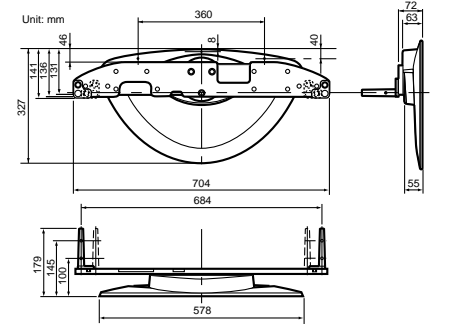

## Ceiling-hanging bracket

TY-CE42PS7

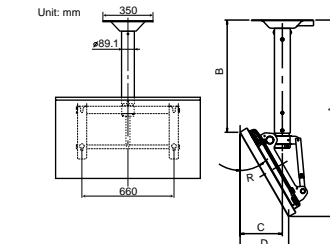

R	0°	15°	30°
A	1187	1287	1387
B	466	566	666
C	199	240	286
D	0	186	360

R	0°	15°	30°
A	1130	1230	1330
B	523	623	723
C	193	228	252
D	0	157	303

## Mobile stand

TY-ST58PF10

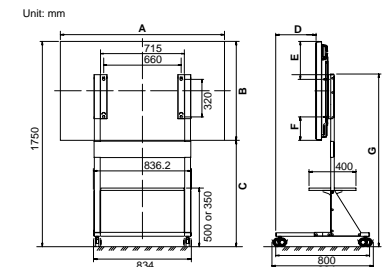

	58" model	50" model	42" model
A	1399	1210	1020
B	843	724	610
C	907	1026	1140
D	343.9	354.1	360.2
E	323.5	202	145
F	199.5	202	145
G	1471.6	1587.6	1644.6

## Anti-glare filter

TY-AR65P9W (for TH-65PF10TK)  
TY-AR58P10W (for TH-58PH10TK)

TY-AR50P9W (for TH-50PH10TK/TS)  
TY-AR42P9W (for TH-42PH10TS, TH-42PS10TK/TS)

## Detachable stereo speakers



Photo shows TY-SP42P8W-K.

Photo shows TY-SP42P8W-S.

**TY-SP65P10WK** (for TH-65PF10TK)  
Configuration: 2-way, 3-speaker  
Dimensions (W x H x D): 111 x 925 x 90 mm  
Weight: 2.2 kg/each  
**TY-SP58P10WK** (for TH-58PH10TK)  
Configuration: 2-way, 3-speaker  
Dimensions (W x H x D): 107 x 843 x 88 mm  
Weight: 2.5 kg/each

**TY-SP50P8W-K** (for TH-50PH10TK)  
**TY-SP50P8W-S** (for TH-50PH10TS)  
Configuration: 2-way, 3-speaker  
Dimensions (W x H x D): 107 x 724 x 88 mm  
Weight: 2.0 kg/each  
**TY-SP42P8W-K** (for TH-42PS10TK)  
**TY-SP42P8W-S** (for TH-42PH10TS, TH-42PS10TS)  
Configuration: 2-way, 3-speaker  
Dimensions (W x H x D): 107 x 610 x 88 mm  
Weight: 2.0 kg/each